

HEAVY DUTY SWITCH

ZEN75 800LR

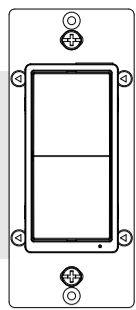

Scan to register your product for extended warranty and direct access to firmware files.



ZOOZ™  
smart move

www.getzooz.com  
ask@getzooz.com



FEATURES

- Manual or Z-Wave on/off control with instant status updates
- Works with LED lights up to 600 W, incandescent up to 1800 W
- Works with motors 1 HP at 120VAC or 3 HP at 204 VAC
- **800 series Z-Wave** chip for better range and faster control
- **Direct 3-Way:** works with regular on/off switches in a 3-way
- **Scene control:** trigger actions with multi-tap (select hubs only)
- **Smart bulb mode:** disable relay and control the light via Z-Wave
- **Z-Wave Long Range** for ultra reliable no-mesh communication
- Remembers and restores on/off status after power failure

SPECIFICATIONS

- Model Number: ZEN75 800LR
- Z-Wave Region: US / CA / MX
- Power: 120-277V AC, 50/60 Hz
- **Maximum Load:** 600W LED, 1800W Incandescent, 15 A Resistive / Tungsten / Incandescent, 10 A Inductive Ballast / Electronic Ballast / LED, 1 HP at 120 VAC / 3 HP at 240 VAC Motor
- Range: Up to 500 feet line of sight (or 1300 feet with ZWLR)
- Operating Temperature: 32-104° F (0-40° C)
- Installation and Use: Indoor only

CAUTION

This is an electrical device - please use caution when installing and operating the on/off switch. Remote control of appliances may result in unintentional or automated activation of power. Do not use this Z-Wave device to control electric heaters or other appliances which produce the risk of fire, burns, or electrical shock when unattended. To reduce risk of overheating and possible damage to other equipment, do not install this unit to control a receptacle; a motor-operated appliance; a fluorescent lighting fixture; or a transformer-supplied fixture.

BEFORE YOU INSTALL

This switch is intended for installation in accordance with the National Electric Code and local regulations. It is recommended that a licensed electrician perform this installation.

WIRING: READ IT!

- CHECK THE LOAD:** make sure that the load you're about to connect is within the electrical specs of this switch listed on the back of the device. Do NOT overload the switch.
- POWER OFF:** turn the circuit power off in the breaker panel before you start. If installing in a multi-switch box with multiple circuits, turn power off at all of the circuits.
- CHECK THE WIRES:** mark load (most often black), line (most often black), neutral (most often white), and ground (most often bare). Don't rely exclusively on your multimeter to identify the wires!

NOT SURE WHAT YOU'RE SEEING? WE'LL HELP! SUPPORT.GETZOOZ.COM SEND US PICTURES OF YOUR SET-UP, BEFORE YOU DISCONNECT WIRES.

- REMOVE THE OLD SWITCH:** disconnect the wires and label them with the included label stickers.
- CONNECT THE Z-WAVE SWITCH:** follow all installation steps carefully. Wire the switch EXACTLY like in the diagram.

ZEN75 WIRING DIAGRAM FOR SINGLE POLE INSTALLATION

- Connect the ground (bare) wire with the green **Ground** pigtail on the switch (ground wires aren't shown in the diagram).
- Connect the power source wire with the black **Line** pigtail and load wire to the yellow **Load** pigtail. **Load and line CAN'T be swapped, don't attempt unless you're 100% sure!**

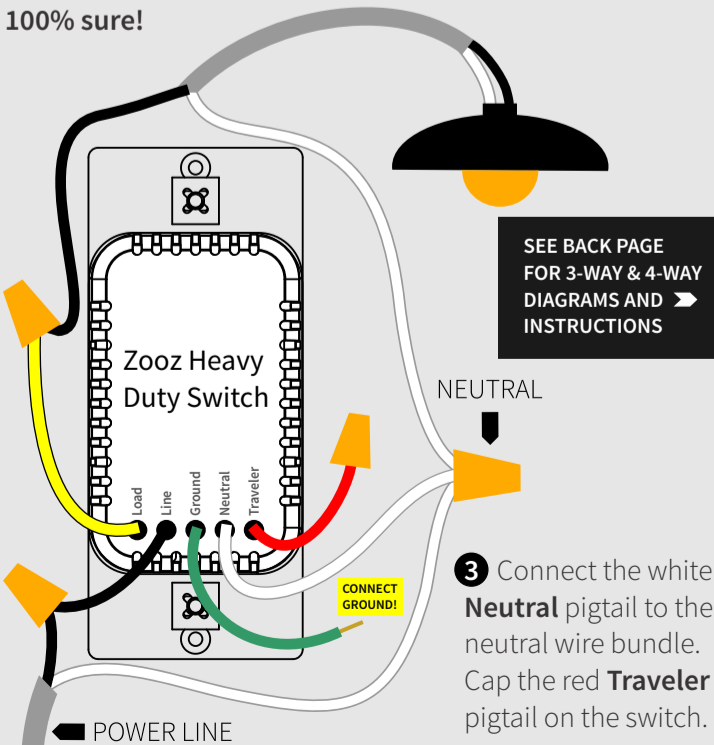

SEE BACK PAGE FOR 3-WAY & 4-WAY DIAGRAMS AND INSTRUCTIONS

NEUTRAL

- Connect the white **Neutral** pigtail to the neutral wire bundle. Cap the red **Traveler** pigtail on the switch.

DON'T TURN THE POWER BACK ON UNTIL THE SWITCH IS FULLY INSTALLED AND ARRANGED BACK IN THE BOX.

SAFETY FIRST!

Wire colors and romex layout are for illustration only. You should not follow the colors and positioning in the illustration blindly. Always identify all wires prior to installing Zooz switches and make sure you can match the diagrams to your set-up exactly. Don't experiment or attempt a "trial-and-error" installation for your own safety. Always cap any exposed wires and isolate electrical elements with appropriate protection.

COMPLETE INSTALLATION

Secure your Z-Wave switch in the box with mounting screws, handling the wires with care. Isolate all bare wires with electrical tape. Install the wall plate and only now restore power to circuit.

TEST THE SWITCH

The LED indicator should light up as soon as you turn the power back on if the switch (light) is OFF. Tap the upper paddle for ON and lower paddle for OFF. **If the test fails, please check that:**

- power is fully restored to the circuit
- wiring matches the instructions **exactly**
- the load isn't too large and overheating the switch causing it to shut off

WARNING

- This product should be installed indoors upon completion of any building renovations.
- Prior to installation, the device should be stored in a dry, dust-and-mold-proof place.
- Do not install the switch in a place with direct sun exposure, high temperature, or humidity.
- Keep away from chemicals, water, and dust.
- Ensure the device is never close to any heat source or open flame to prevent fire.
- Ensure the device is connected to an electric power source that does not exceed the maximum load power.
- No part of the device may be replaced or repaired by the user.

Z-WAVE CONTROL



1. ADD DEVICE to your hub

Initiate inclusion (pairing) in the app (or web interface).

Not sure how? Scan one of the QR codes below for step-by-step instructions or get in touch: [www.support.getzooz.com](http://www.support.getzooz.com)

- Finalize inclusion at the switch. **TAP UP 3 TIMES QUICKLY** if using traditional Z-Wave inclusion.

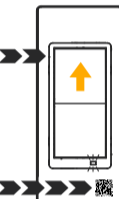

SCAN THE QR CODE / ENTER THE 5-DIGIT DSK if using the SmartStart method.

The LED indicator will blink blue to signal communication and turn green for 3 seconds if inclusion is successful or turn red for 3 seconds if the pairing attempt fails.

NEED SOME HELP? [ask@getzooz.com](mailto:ask@getzooz.com)

Choose your hub and scan the QR code with your phone's camera. Then click on the link to access the step-by-step pairing instructions.



SmartThings



Hubitat



Home Assistant



Z-Box Hub

Get more tutorials and helpful tips at [www.support.getzooz.com](http://www.support.getzooz.com)

TROUBLESHOOTING

The switch won't add to your system? Try this:

- Initiate **EXCLUSION** and tap the lower paddle 3 times quickly.
- Tap the upper paddle **4-5 times quickly** when adding it.
- Bring the gateway controller (hub) **closer** to the switch, it may be out of range.
- Get troubleshooting tips for your hub at [www.support.getzooz.com](http://www.support.getzooz.com)

The switch won't control the lights manually anymore? Try this:

- Turn the power off at the breaker and check if a wire didn't get loose.
- Exclude the switch from the hub or **reset** it in case manual control was accidentally disabled.
- The load may be incompatible so try it with a single incandescent bulb.

EXCLUSION (REMOVING / UNPAIRING DEVICE)

- Bring your Z-Wave gateway (hub) close to the switch if possible
- Put the Z-Wave hub into **exclusion mode** (not sure how to do that? [ask@getzooz.com](mailto:ask@getzooz.com))
- Tap the **lower paddle** on the switch **3 times quickly** (the LED indicator will start blinking blue)
- Your hub will confirm exclusion, the LED indicator on the switch will turn green for 3 seconds, and the device will disappear from your controller's device list

FACTORY RESET

If your primary controller is missing or inoperable, you may need to reset the device to factory settings. To reset the switch, **press and hold the lower paddle for 10 seconds** until the LED indicator starts blinking. Release paddle, and immediately after, **tap the lower paddle 5 times** to complete the reset. The LED indicator will flash blue 3 times and turn red for 3 seconds to confirm successful reset.

**NOTE:** All previously recorded activity and custom settings will be erased from the device's memory.

ADVANCED SETTINGS

Please refer to your controller's user guide for advanced programming instructions as they are a little different for every software.

**Not sure where to start? Go to [www.support.getzooz.com](http://www.support.getzooz.com) for detailed instructions on how to change the settings on SmartThings, Vera, and more.**

Or just email us: [ask@getzooz.com](mailto:ask@getzooz.com)

CUSTOMIZE YOUR SWITCH

Here is a selection of settings available to customize your switch. **Scan the QR code for a full list of parameters** and look below for how to access them on your hub.

- **LED Indicator** behavior, color, brightness: 6 x TAP UP to change the indicator mode
- **Smart Bulb Mode** (disable the relay): HOLD UP for 10 seconds then 5 x TAP UP
- On/off status after **power failure**

SCAN SETTINGS



Choose your hub and scan the QR code with your phone's camera. Then click on the link to learn how to access and change the advanced settings for the switch on your hub.



SmartThings



Hubitat



Home Assistant



Z-Box Hub

SCENE CONTROL

You can trigger scenes or control other connected devices in your network using this switch. Just enable the setting in Parameter 9 and verify that your hub supports scene control. Assign scenes or actions to 1-tap, 2-tap, 3-tap, 4-tap, and 5-tap as well as to held and released for any of the paddles.

Scan the QR code for scene control programming instructions on your hub.



QUESTIONS?

[ask@getzooz.com](mailto:ask@getzooz.com)

ASSOCIATION

This on/off switch supports Group 1 with up to 1 devices for lifeline communication and Group 2 with up to 5 devices. This device will send BASIC REPORT to Group 1 and BASIC SET command to group 2 when operated manually. You can set direct association to have the switch control another Z-Wave device independently of the hub by using Group 2. Not every hub exposes direct association settings in the interface so please go to [www.support.getzooz.com](http://www.support.getzooz.com) to see if your system allows for direct association.



This product can be included and operated in any Z-Wave network with other Z-Wave certified devices from other manufacturers and/or other applications. All non-battery operated nodes within the network will act as repeaters regardless of vendor to increase reliability of the network. This product features the latest Security 2 (S2) framework to remove smart home network hacking risks. This device is equipped with a unique authentication code for trusted wireless communication.

**This is an ETL certified device.** ETL, just like UL, is a Nationally Recognized Testing Laboratory. The ETL mark is proof of product compliance with North American safety standards.

WARRANTY

This product is covered under a 1-year limited warranty and extended 5-year warranty once registered. To read the full warranty policy or file a warranty claim, please go to [www.getzooz.com/warranty](http://www.getzooz.com/warranty)

**IN NO EVENT SHALL ZOOZ OR ITS SUBSIDIARIES AND AFFILIATES BE LIABLE FOR ANY INDIRECT, INCIDENTAL, PUNITIVE, SPECIAL, OR CONSEQUENTIAL DAMAGES, OR DAMAGES FOR LOSS OF PROFITS, REVENUE, OR USE INCURRED BY CUSTOMER OR ANY THIRD PARTY, WHETHER IN AN ACTION IN CONTRACT, OR OTHERWISE EVEN IF ADVISED OF THE POSSIBILITY OF SUCH DAMAGES. ZOOZ'S LIABILITY AND CUSTOMER'S EXCLUSIVE REMEDY FOR ANY CAUSE OF ACTION ARISING IN CONNECTION WITH THIS AGREEMENT OR THE SALE OR USE OF THE PRODUCTS, WHETHER BASED ON NEGLIGENCE, STRICT LIABILITY, BREACH OF WARRANTY, BREACH OF AGREEMENT, OR EQUITABLE PRINCIPLES, IS EXPRESSLY LIMITED TO, AT ZOOZ'S OPTION, REPLACEMENT OF, OR REPAYMENT OF THE PURCHASE PRICE FOR THAT PORTION OF PRODUCTS WITH RESPECT TO WHICH DAMAGES ARE CLAIMED. ALL CLAIMS OF ANY KIND ARISING IN CONNECTION WITH THIS AGREEMENT OR THE SALE OR USE OF PRODUCTS SHALL BE DEEMED WAIVED UNLESS MADE IN WRITING WITHIN THIRTY (30) DAYS FROM ZOOZ'S DELIVERY, OR THE DATE FIXED FOR DELIVERY IN THE EVENT OF NONDELIVERY.**

**FCC NOTE**  
THE MANUFACTURER IS NOT RESPONSIBLE FOR ANY RADIO OR TV INTERFERENCE CAUSED BY UNAUTHORIZED MODIFICATIONS TO THIS EQUIPMENT. SUCH MODIFICATIONS COULD VOID THE USER'S AUTHORITY TO OPERATE THE EQUIPMENT. STORE INDOORS WHEN NOT IN USE. SUITABLE FOR DRY LOCATIONS ONLY. DO NOT IMMERSE IN WATER. NOT FOR USE WHERE DIRECTLY EXPOSED TO WATER.

This device complies with Part 15 of the FCC Rules. Operation is subject to the following conditions:  
1. This device may not cause harmful interference,  
2. This device must accept any interference received, including interference that may cause undesired operation. This equipment has been tested and found to comply with the limits for a Class B digital device, pursuant to part 15 of the FCC Rules. These limits are designed to provide reasonable protection against harmful interference in a residential installation. This equipment generates, uses and can radiate radio frequency energy and, if not installed and used according to instructions, may cause harmful interference to radio communications. However, there is no guarantee that interference will not occur in any given installation. If this equipment causes harmful interference to radio or television reception, the user may try to correct the interference by taking one or more of the following measures:  
- Reorient or relocate receiving antenna  
- Increase the separation between equipment and receiver  
- Connect equipment into a separate outlet or circuit from receiver  
- Consult the dealer or an experienced radio/TV technician for additional assistance

All brand names displayed are trademarks of their respective holders.  
© Zooz 2025

# ZEN75 WIRING DIAGRAMS FOR THE MOST COMMON 3-WAY INSTALLATIONS

For more diagrams or to request custom instructions go to [support.getzooz.com](http://support.getzooz.com)

## 3-WAY DIAGRAM FOR 2-POINT CONTROL WITH ZEN75 AND REGULAR 3-WAY SWITCH: OPTION 1

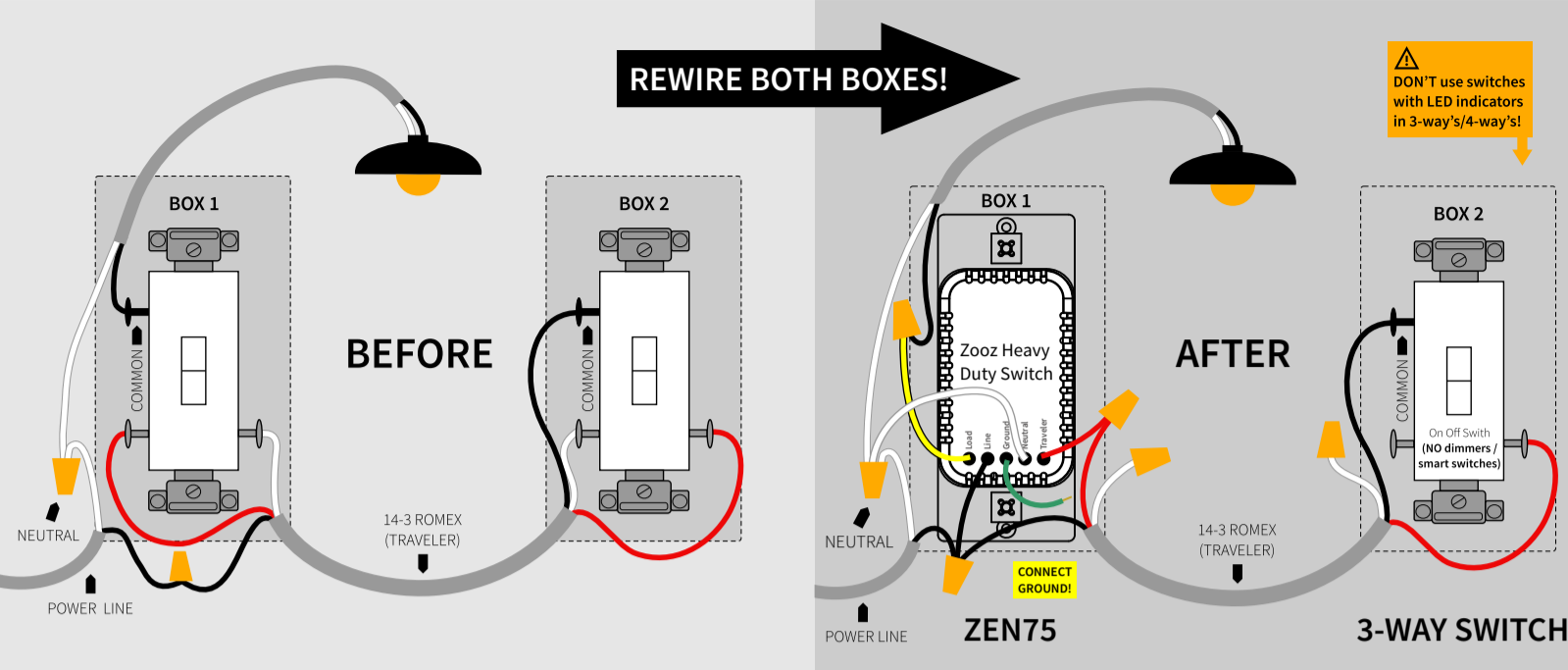

### STOP!

Wire and screw position, as well as color codes are for illustration only. You should not follow the colors and positioning in the illustration blindly. Always identify all wires prior to installing Zooz switches and make sure you can match the diagrams to your set-up exactly. Don't experiment or attempt a "trial-and-error" installation for your own safety. Don't disconnect any wires before documenting your set-up in each box with detailed images!

### NOTE!

If you are not comfortable identifying the wiring and completing the installation, please consult a licensed electrician. Make sure you have identified all wiring correctly before connecting the switch. If your wiring doesn't match any of the below diagrams, contact our support: [ask@getzooz.com](mailto:ask@getzooz.com)

## 3-WAY DIAGRAM FOR 2-POINT CONTROL WITH ZEN75 AND REGULAR 3-WAY SWITCH: OPTION 2

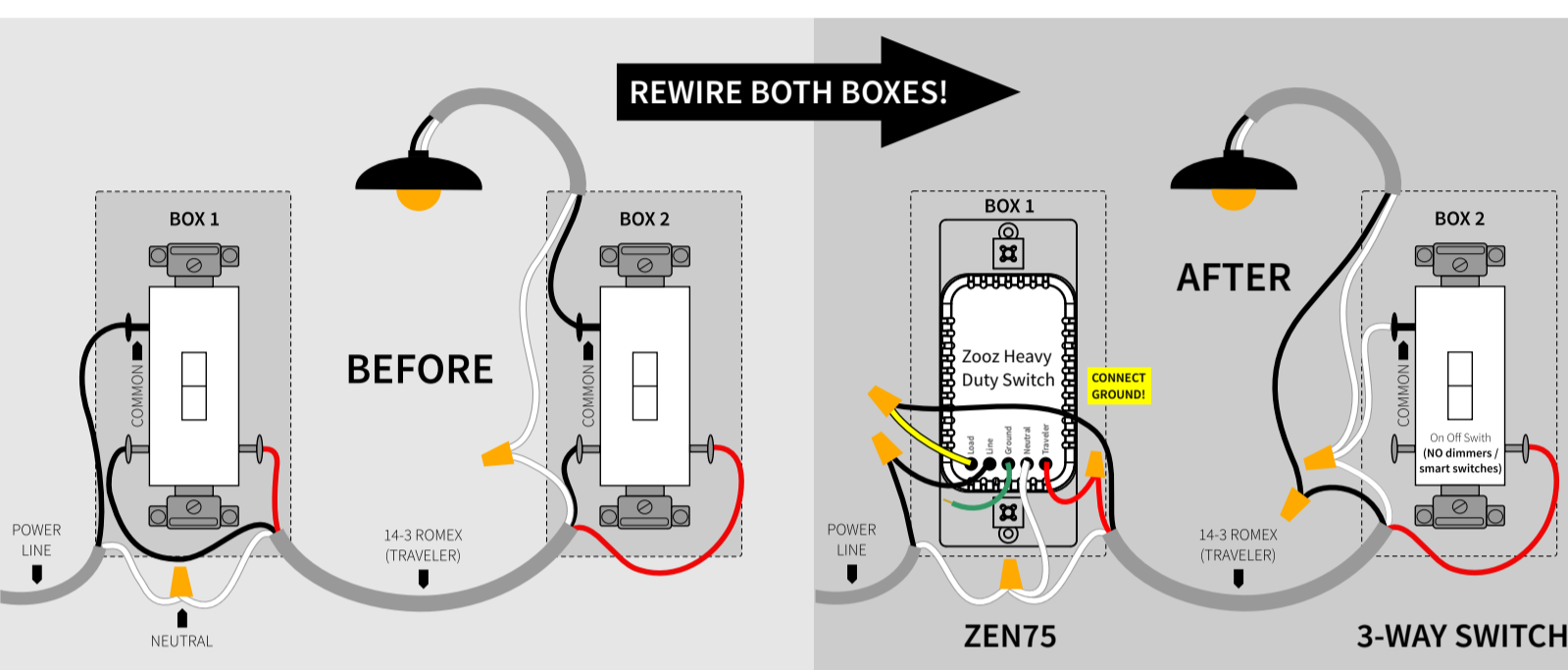

### ON/OFF SWITCHES ONLY

Do not connect Zooz Z-Wave switches to an existing 3-way dimmer, illuminated switch, or an electronic add-on switch. Zooz switches can only be wired with mechanical on/off or momentary switches in a 3-way or 4-way setting! To simplify the diagrams, we did not include connections for the ground wire. Remember that all Zooz switches need to be wired according to the electrical code, with ground wire connected to the ground terminal.

### POWER OFF!

Cut power to the circuit before handling the wiring. Always install your Zooz switch in the box with direct connection to power line. Diagrams and instructions in this manual are for ZEN75 model ONLY!

## ZEN75 4-WAY INSTALLATION WIRING DIAGRAM (LINE AND LOAD MUST BE IN THE SAME BOX)

**NOTE:** Use regular 3-way on/off switches ONLY in this set-up (replace any 4-way switches or 3-way dimmers if needed). To simplify the diagrams, we did not include connections for the ground wire. Remember that all Zooz switches need to be wired according to the electrical code, with ground wire connected to the ground terminal.

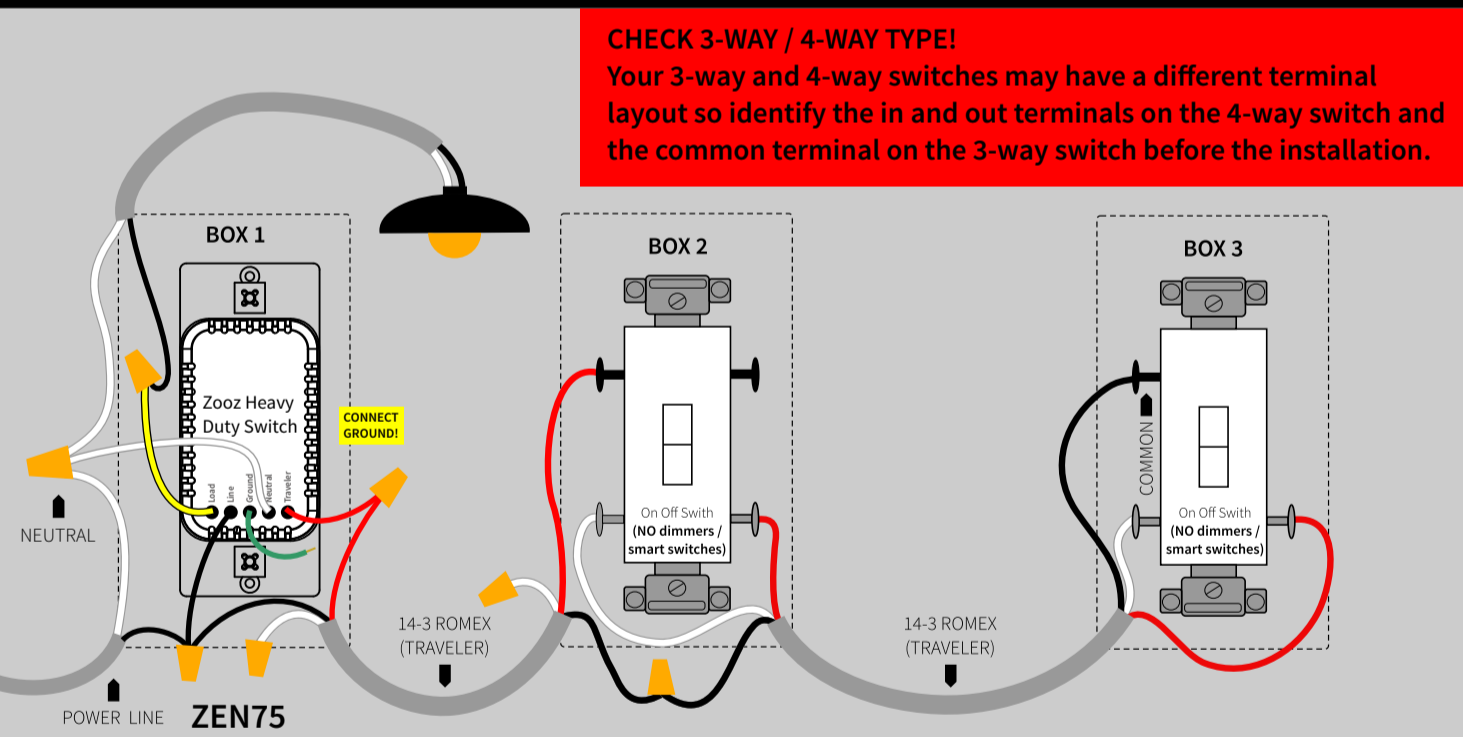

EACH BOX NEEDS TO BE REWIRED ACCORDING TO THE 4-WAY DIAGRAM.

Follow this diagram ONLY if you confirmed you have direct connection to power and light in the same box. If they're in separate boxes, ask us about using the ZEN75 switch with ZAC99 momentary switches in 4-way and 5-way installations.

If you have power or load coming into the box with the 4-way switch, contact us for custom instructions: [ask@getzooz.com](mailto:ask@getzooz.com)

## ZEN75 SINGLE POLE INSTALLATION FOR 240 V MOTOR LOAD

**NOTE:** To simplify the diagrams, we did not include connections for the ground wire. Remember that all Zooz switches need to be wired according to the electrical code, with ground wire connected to the ground pigtail on the switch.

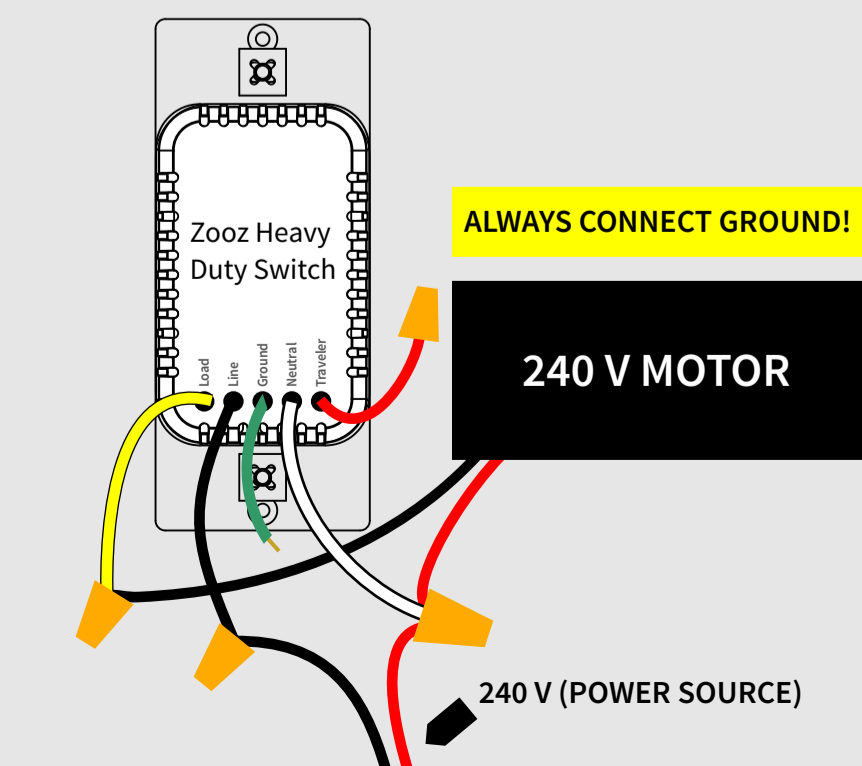

### NEED HELP?

If you're having trouble reading the diagrams or don't see your wiring set-up here, get in touch! We have **more 3-way, 4-way, and 5-way diagrams** and will create custom instructions for your set-up if needed.

There are many ways to wire multi-point control set-ups as well as high-voltage motors, pumps, and fans so unless you can match your wiring to the diagrams here, please don't attempt the installation for your own safety.

[www.support.getzooz.com](http://www.support.getzooz.com)

[ask@getzooz.com](mailto:ask@getzooz.com)